



6185 / 00



6001 / 00

Neue Nr. 107886 - Bügel mit Kette (Seesack)



107900SPO

(Messinghülse
107901SPO

Bajonettverschl.
107902SPO



6312

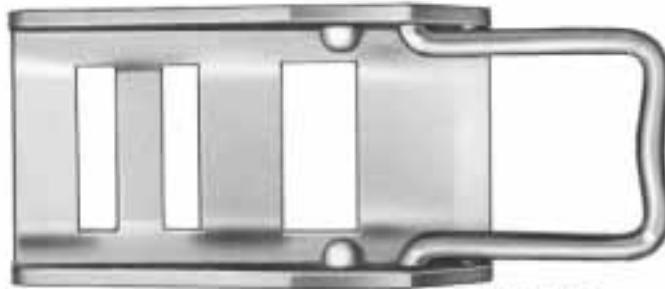

6076 / 21mm



6159 / 16



6163 / 00



6182 / 18

Bannerspitze
1/3 natürl. Größe



6115 / 20



6175 / 16



6269 / 20



6311



6315 / 20

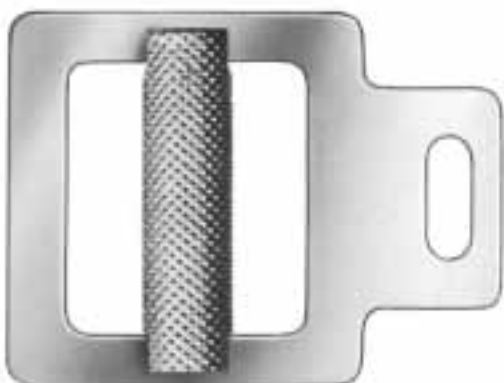

6062 / 20 / 35

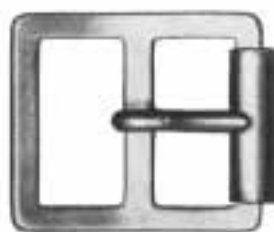

6235 / 25



6166 / 26



6256

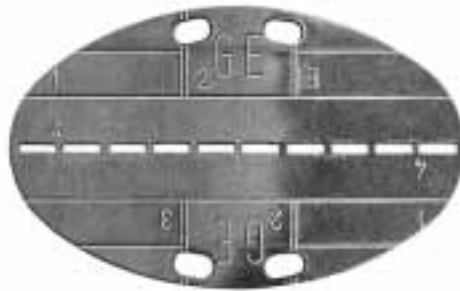

6080 / 00 ohne Kette

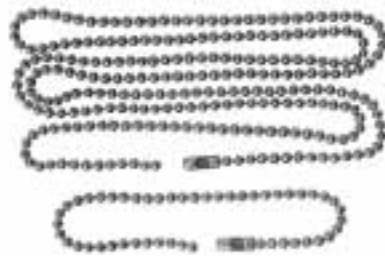

6080 / 01 mit Kette



6206 / 35



6238 / 40



6145



6248 / 40

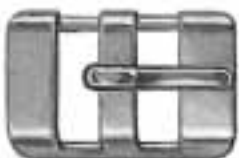

6218 / 12



6188



6110



105676

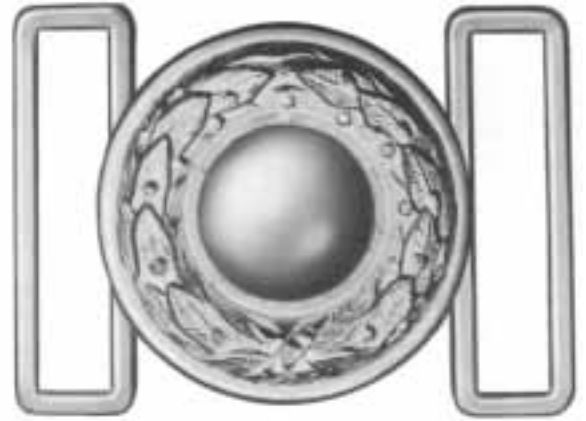

105676



105676



6278 / 35

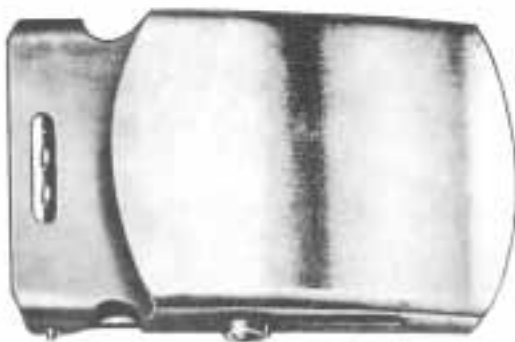

6296 / 35



6296 / 32



6046 / 20



6046 / 30



6046 / 32



6046 / 35



6304 / 30



6034 / 50



6035 / 50

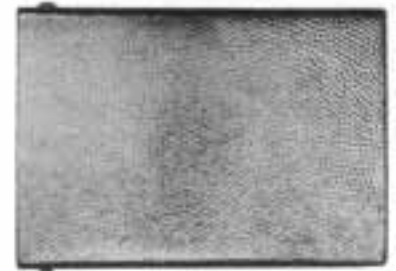

6032 / 32



6033 / 32

6033 / 02 Niet



6036 / 50



6037 / 50



6038 / 50



6026 / 35

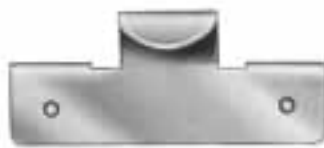

6180 / 45 2,25mm Loch

6180 / 4599 Niet

6167 / 45 4mm Loch ohne Niet



6028 / 35



6031 / 45



6519 / 50



6520 / 5099

6520 / 50



6015 / 45

6023 / 00



6016 / 45



6132 / 45



6030 / 45 oder 18478 LOU



6179 / 45



6022 / 45



6018 / 45



6020 / 45



6021 / 45



6125 / 45



6162 / 45



6181 / 45



6203 / 45



6212 / 45



5003



5004



5005



5006



6294 / 25



6150 / 50



5008



5009



5010



5035 / 35



5002 / 25



6049 / 25



5050 / 50



5051 / 50



5052 / 35

Rundringe / O-Rings / Anneaux ronds
 Halbringe / D-Rings / Anneaux dés
 Vierkanringe / Frames / Rectangles, Coulants
 Trapezringe / Trapezoidal shaped rings / Trapèzes

Dreieckringe / V-Rings / Triangles
 Griffringe / Handle rings / D pour poignées
 Schieber / Adjusters / Coulisseau
 Schiebsteigschnalle / Sliding buckles /
 Passants coulants

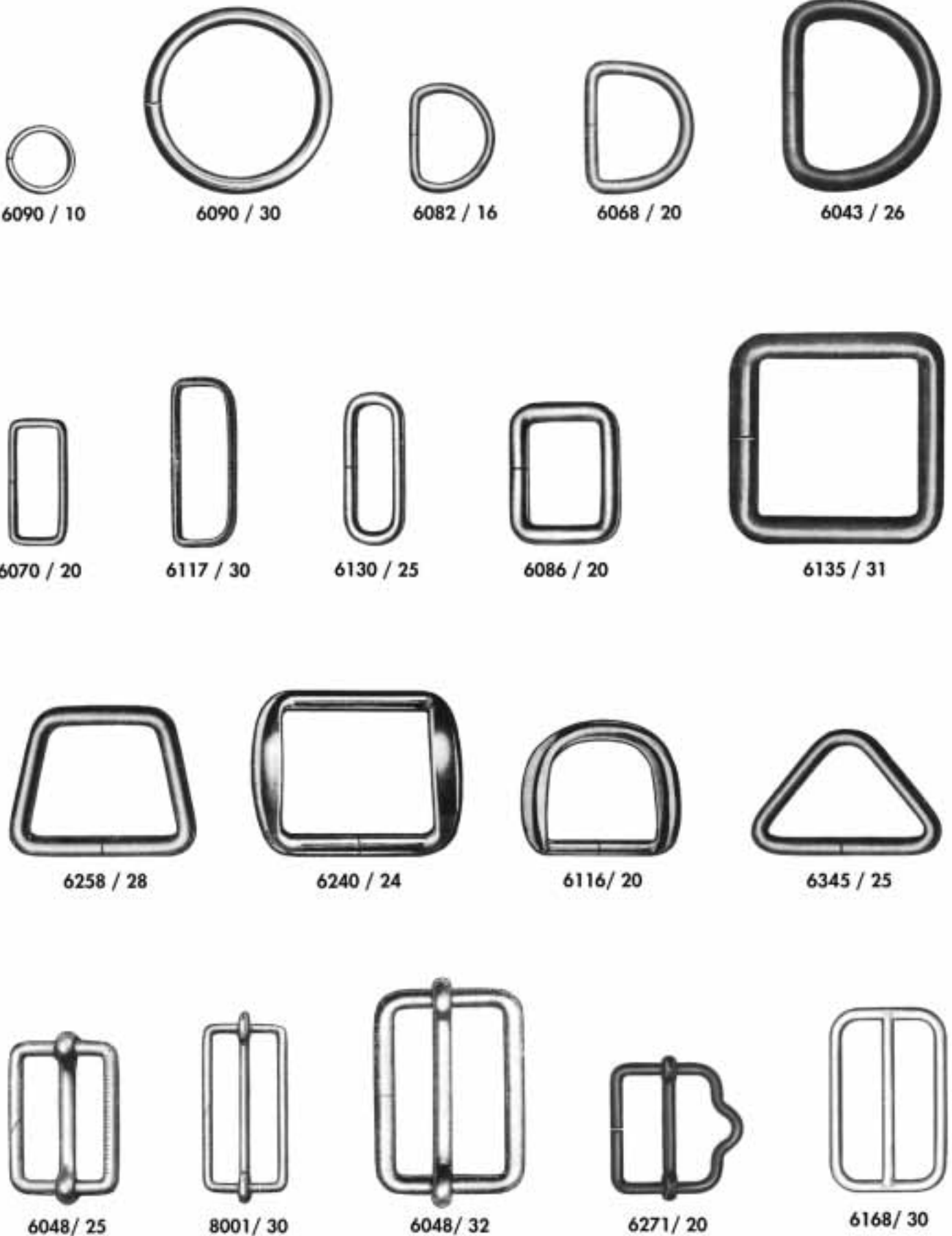



6133/ 25



6347/ 20



6211/ 20



6286/ 25



6160/ 22



6063/ 21



6141/ 21



6039/ 30

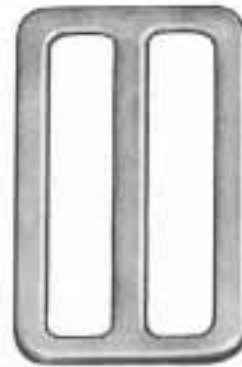

6257/ 40



6040/ 18



6098/ 40



6149/ 16

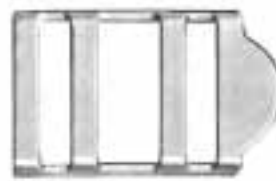

6149/ 20

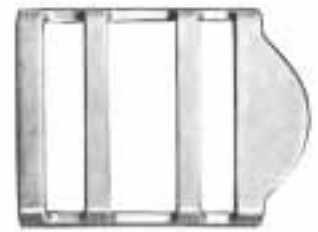

6149/ 25



6124 /20



6071



6111/ 20



6044/ 20



6041/ 16



6073/ 20



6073/ 40



6147/ 27



6229/ 30



6299/ 32



6265/ 35

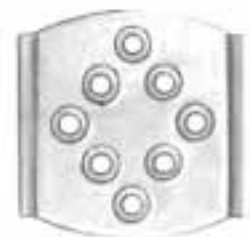

6170/ 00



6245/ 29



6202/ 00



6172/ 25

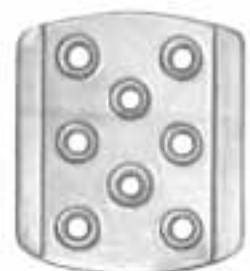

6171/ 00



6047 / 21



6174 / 26



6127 / 26



6268 / 19



6197

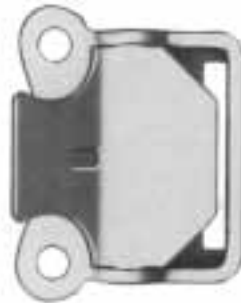

6200 / 00



6232 / 26



6140 / 25



6107 / flach

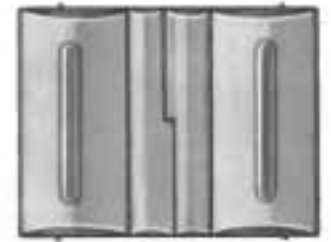

8023 / 30

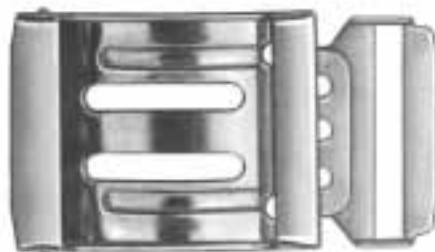

6274 / 30 (VG 95517)



8000 / 30



8016 / 30



6143 / 25



6107 / 14



6321



6322



19718



6323



6324



6327



6010



6008 / 20



6223



6226 / 12



6319



6320 Foto falsch



6186 / 22

6250 / 22



6057



6058



6007



6005



6006



6280



6281



6279



6282



6272 / 16



6266



6328



6092



6176



6011



6012



6009 / 19 MS
6316 / 19 FE



6302



6013 / 30



6348 / 32
Foto nicht aktuell



6301 / 33



6014 / 25



6069 / 20



6253 / 25



8028 / 45



8024 / 30



8031 / 30



8034 / 30



6074 / 20
ohne Dorn
6115 / 20
mit Dorn



6093 / 00



6118 / 32



6126 / 19



6002 / 20



6088 / 20



6254 / 28



6136 / 00



6197 / 00



6270



6270 / 01



6270 / 02



6270 / 03



6270 / 04



6270 / 05



6329



6330



6331



6291



6097



6113



6155



6094



8 x 5



8 x 7



6114



10 x 7



10 x 5



6332



6209



6333



6334



6335



6336



6337



6261



6153



6233



6338



6339



6340



6341



6195
Sechskantmutter



6342



6208



6184



6230



6251



6128



6108



6210



6220



6273



6313



6187 / 27



6095 / 27



6096 / 42



6060 / 26



6191 / 00



6157 / 28



6283 / 30

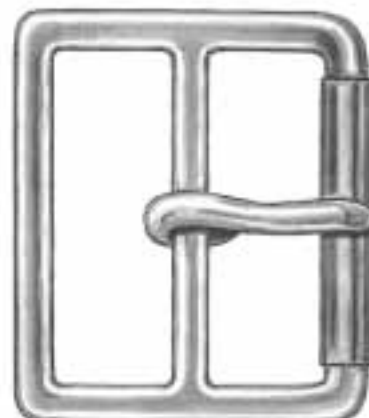

6287 / 45



6104 / 40

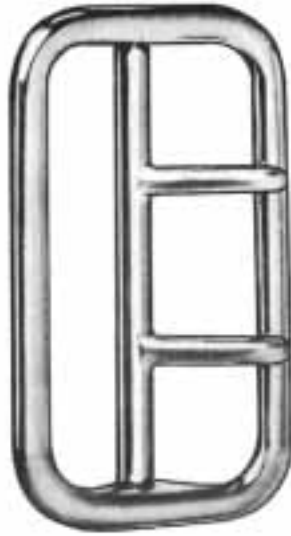

6104 / 58

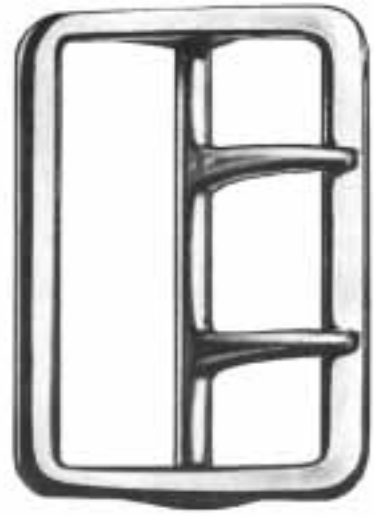

6277 / 57

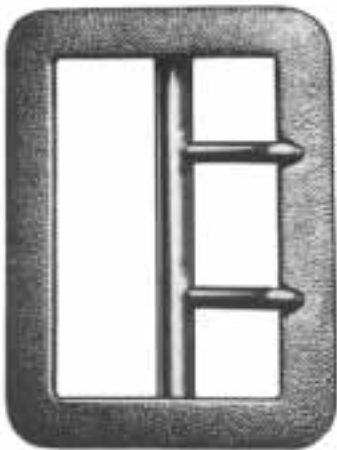

6050 / 45

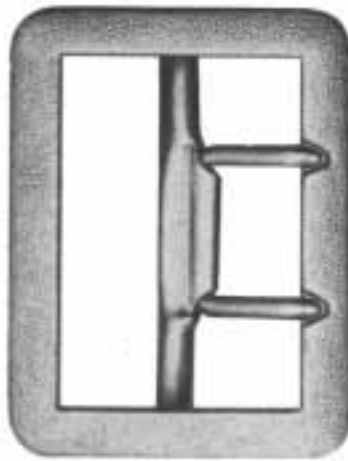

6052 / 45

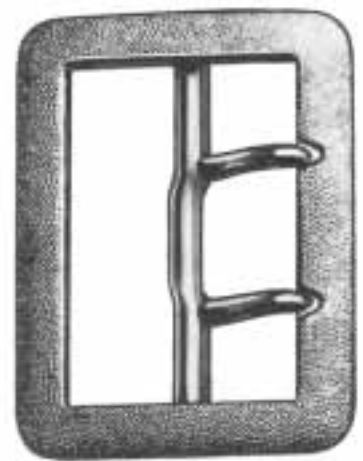

6051 / 45

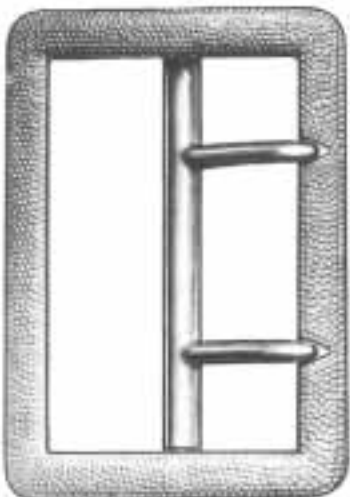

6050 / 52

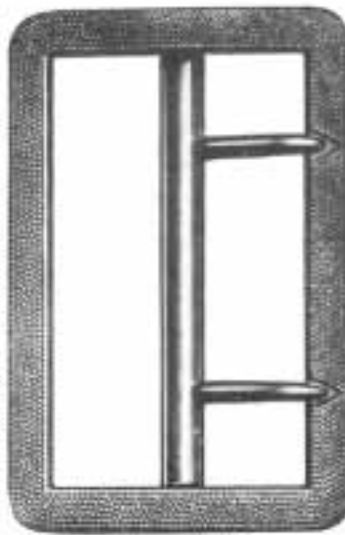

6055 / 55

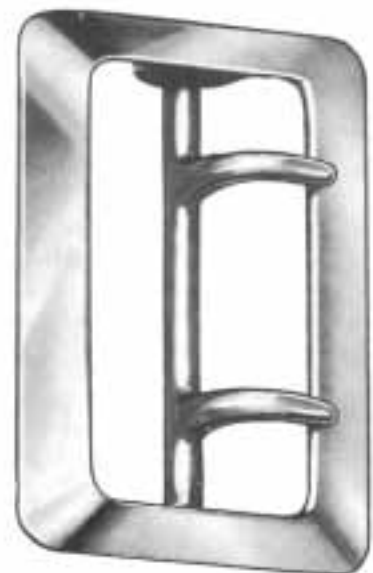

6303 / 58

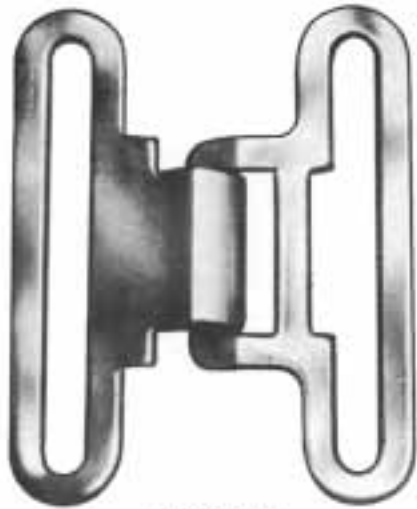

6303 / 57

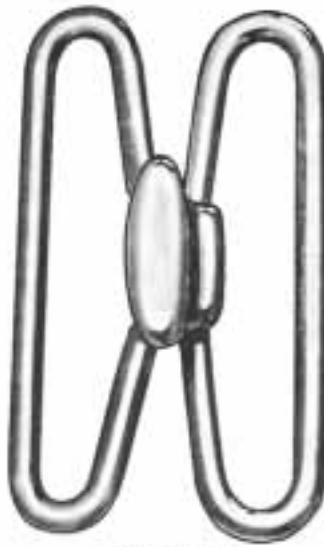

6297 / 60

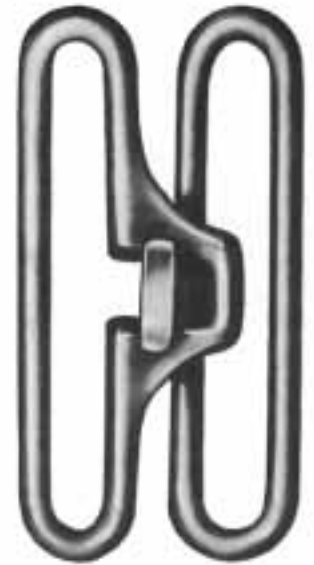

6300 / 60

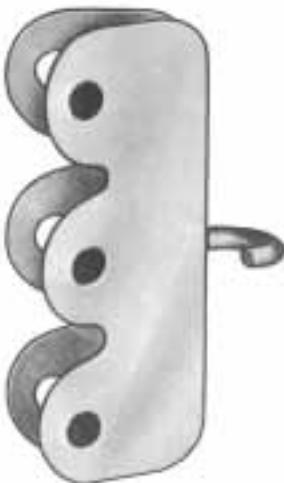

6314 / 59



6307 / 56



6308 / 58



6309 / 57



6310 / 57

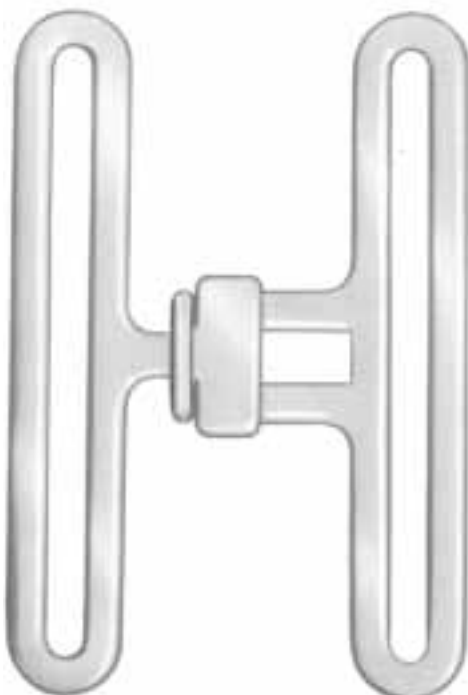

6054 / 80

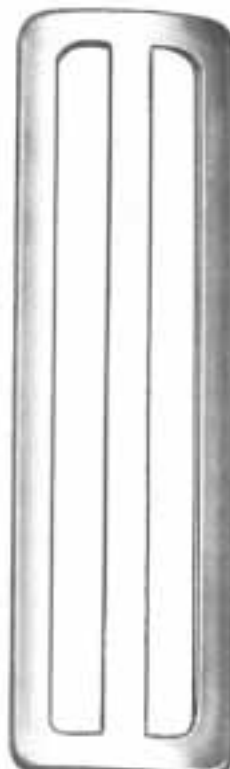

6056 / 80